

Piling and drilling rig

LRB 355.1

EN

LRB 2504.07



LIEBHERR

Concept and characteristics

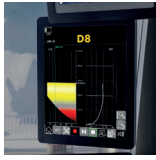

PDE[®]
Process Data Recording

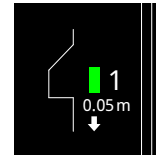

Kelly
Visualization



MyJobsite



Ground
Pressure
Visualization

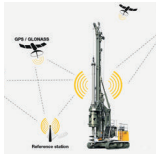

LIPOS[®]
Positioning System



Radio remote
control



LiDAT[®]
Data Transmission



Concrete
pump



The robust universal machine for a wide variety of applications:

- Full displacement drilling
- Continuous flight auger drilling
- Double rotary drilling
- Kelly drilling
- Soil mixing
- Vibrator slim design
- Ring vibrator
- Hydraulic hammer

Assistance systems:

- Cruise Control for all main functions
- Joystick control for all machine functions
- Automatic shake-off function for working tools
- Kelly Visualization
- Ground Pressure Visualization
- Radio remote control for concrete pump
- Drilling assistant (single-pass process)
- Leader inclination memory
- Display of auger filling level
- Kelly winch with freewheeling and with slack rope monitoring and prevention

Technical data



Diesel engine

Power rating according to ISO 9249	600 kW (805 hp) at 1700 rpm 750 kW (1005 hp) at 1700 rpm
Engine type	Liebherr D 9512 A7-04
Fuel tank capacity	1300 l with continuous level indicator and reserve warning
Exhaust emission	complies with EU 2016/1628 Stage V or NRMM exhaust certification EPA/CARB Tier 4f



Hydraulic system

Hydraulic pumps	
for attachments	3x 396 + 2x 430 l/min
for kinematics	215 l/min
Hydraulic oil tank capacity	1100 l
Max. working pressure	400 bar
Hydraulic oil	A system of electronically monitored pressure and return filters cleans the hydraulic oil. Any clogging is displayed in the cabin. The use of synthetic environmentally friendly oil is also possible.



Crawlers

Drive system	with fixed axial piston hydraulic motors
Crawlers	maintenance-free, with hydraulic chain tensioning device
Brake	hydraulically released multi-disc holding brake
Undercarriage type 225	
Drive speed	0-2.1 km/h
Track force	647 kN
Grousers	3-web grousers, width 900 mm
Undercarriage type 260	
Drive speed	0-1.8 km/h
Track force	745 kN
Grousers	3-web grousers, width 1000 mm



Swing gear

Drive system	with fixed axial piston hydraulic motors, planetary gearbox, pinion
Swing ring	triple-row roller bearing with external teeth and 2 swing drives
Brake	hydraulically released multi-disc holding brake
Swing speed	0-2.4 rpm continuously variable



Winches

Kelly winch with free fall	
Line pull effective	250 kN (1 st layer)
Rope diameter	34 mm
Rope speed	0-85 m/min
Optional 30 t Kelly winch with free fall*	
Line pull effective	300 kN (1 st layer)
Rope diameter	34 mm
Rope speed	0-80 m/min
* max. line pull only available in the operating mode Kelly drilling	
Auxiliary winch	
Line pull effective	80 kN (3 rd layer)
Swing range	left 180°, right 90°
Radius adjustment device	2450 mm
Rope diameter	20 mm
Rope speed	0-54 m/min



Crowd system

Crowd system	
Crowd winch	
Crowd force	400/400 kN (push/pull)
Line pull effective	200 kN
Travel with 22 m leader	18.5 m
Travel with 27 m leader	23.5 m
Rope speed	0-70 m/min
Optional free fall for hammer operation	



Noise emission / vibration

Noise emission	according to 2000/14/EC directive	
Emission sound pressure level L_{pA}	75 dB(A)	(in the cabin)
Guaranteed sound power level L_{WA}	110 dB(A)	(of the machine)
Vibration transmitted to the machine operator	< 2.5 m/s ²	(to the hand-arm system)
	< 0.5 m/s ²	(to the whole body)
Optional Eco-Silent Mode		
Guaranteed sound power level L_{WA}	-3 dB(A)	(of the machine)

Remarks:

- Illustrations showing the types of application (e.g. Kelly drilling, continuous flight auger drilling etc.) are examples only.
- Weights can vary with the final configuration of the machine. The figures in this brochure may include options which are not within the standard scope of supply of the machine.

Dimensions

Leader 22 m

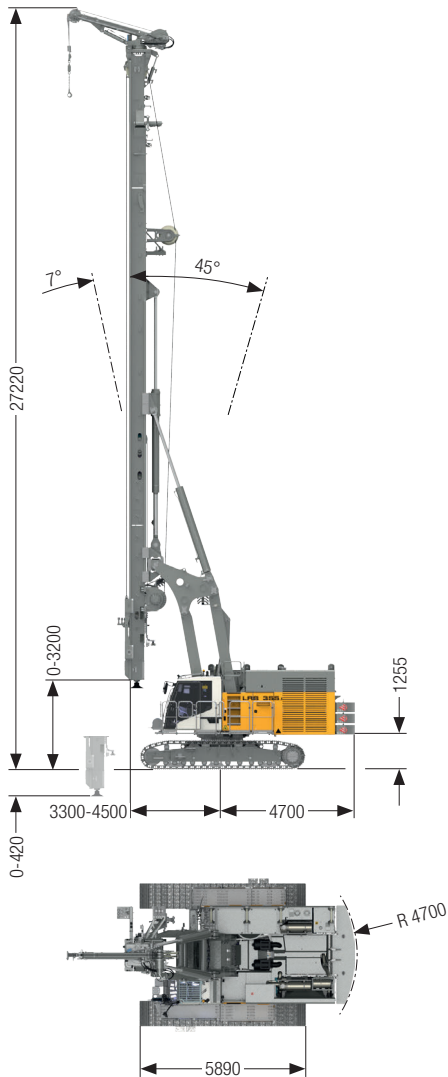

Leader 27 m

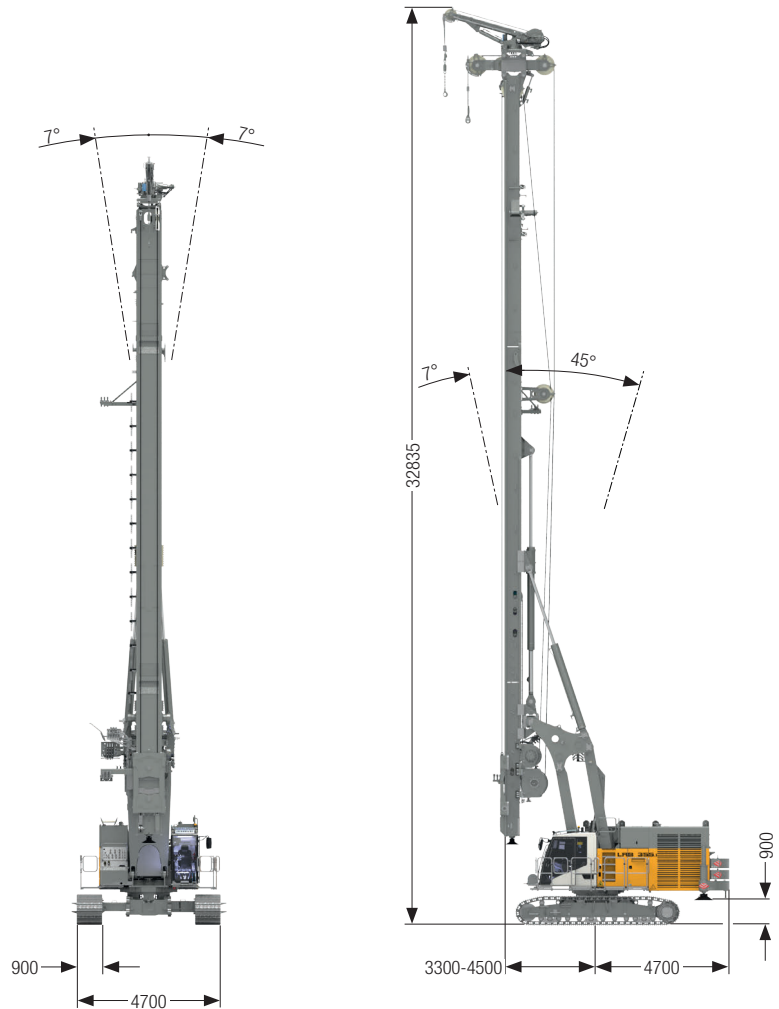

Operating weight

Total weight with undercarriage type 225 t | 95.6
 The operating weight includes the basic machine LRB 355.1 (ready for operation – including 20 % filling of diesel tank) and 3x 6 t counterweight, without attachment and Kelly equipment.

Operating weight

Total weight with undercarriage type 225 t | 101.7
 The operating weight includes the basic machine LRB 355.1 (ready for operation – including 20 % filling of diesel tank) with Kelly equipment and 3x 6 t counterweight, without attachment.

Leader 27 m

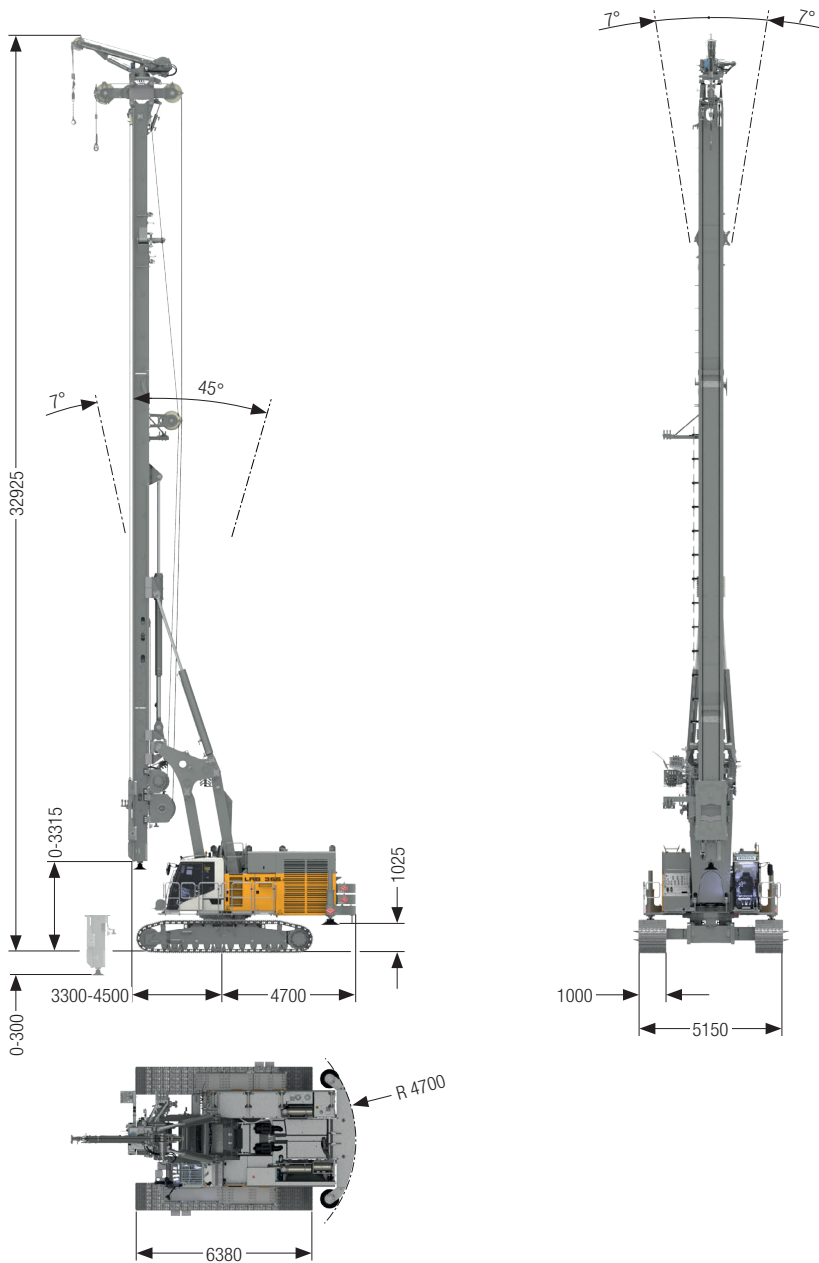

Operating weight

Total weight with undercarriage type 260	t	108.8
--	---	-------

The operating weight includes the basic machine LRB 355.1 (ready for operation – including 20 % filling of diesel tank) with Kelly equipment and 3x 6 t counterweight, without attachment.

Transport and weights

Undercarriage type 225

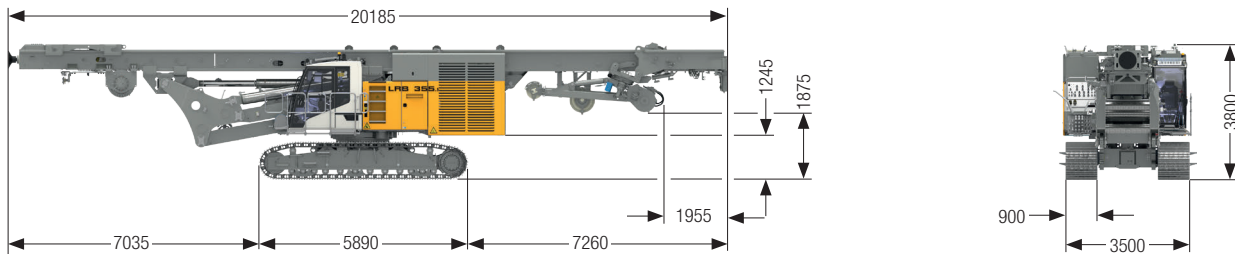

Leader 22m without Kelly equipment

includes the basic machine LRB 355.1 (ready for operation – including 20% filling of diesel tank) without counterweight and attachment. t 77.6

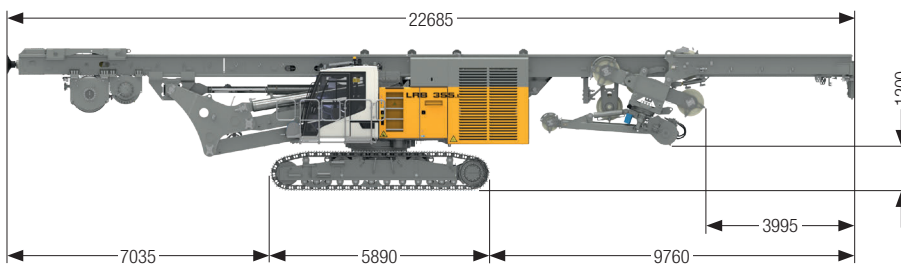

Leader 27m with Kelly equipment

includes the basic machine LRB 355.1 (ready for operation – including 20% filling of diesel tank) without counterweight and attachment. t 83.7

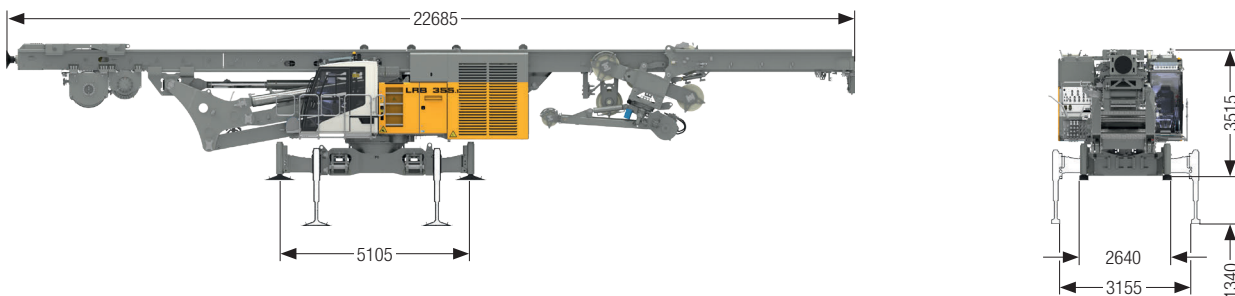

Leader 27m with Kelly equipment, without crawlers, with jack-up system

includes the basic machine LRB 355.1 (ready for operation – including 20% filling of diesel tank) with jack-up system and adapter for casing oscillator, without counterweight and attachment. t 73.1

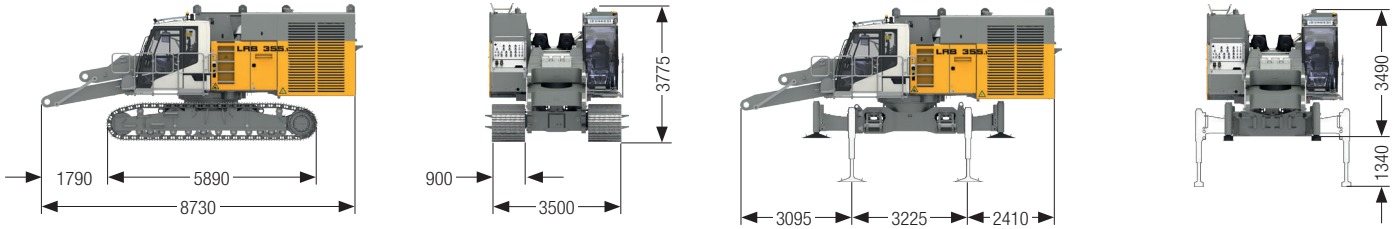

Basic machine versions

without jack-up system, counterweight and adapter for casing oscillator	t	48.7
with jack-up system and adapter for casing oscillator, without counterweight and crawlers	t	38.1

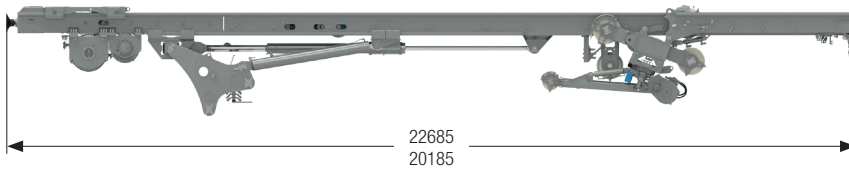

Leader

Leader 22 m without Kelly equipment	t	28.9
Leader 27 m with Kelly equipment	t	35.0

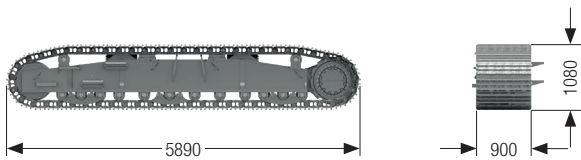

Crawler type 225

Weight	t	7.4
--------	---	-----

Undercarriage type 260

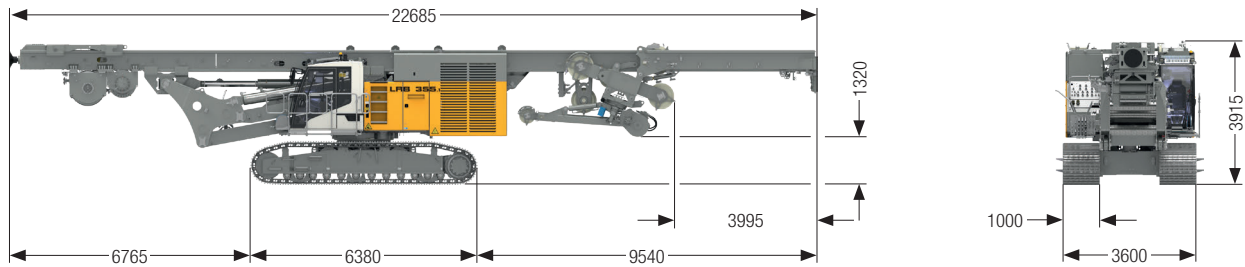

Leader 27 m with Kelly equipment

includes the basic machine LRB 355.1 (ready for operation – including 20 % filling of diesel tank), without counterweight and attachments.

t 90.7

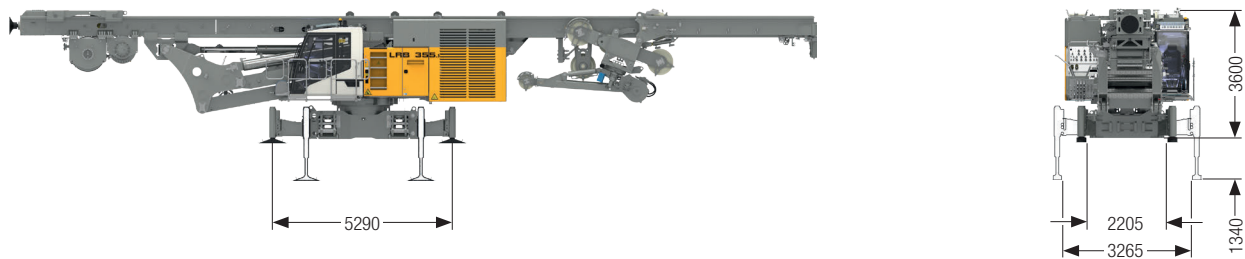

Leader 27 m with Kelly equipment, without crawlers, with jack-up system

includes the basic machine LRB 355.1 (ready for operation – including 20 % filling of diesel tank) with jack-up system and adapter for casing oscillator, without counterweight and attachment.

t 74.4

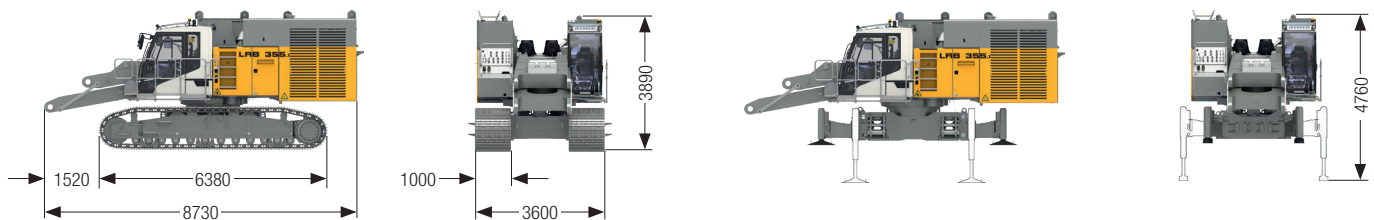

Basic machine versions

without jack-up system, counterweight and adapter for casing oscillator.

t 55.7

with jack-up system and adapter for casing oscillator, without counterweight and crawlers.

t 39.4

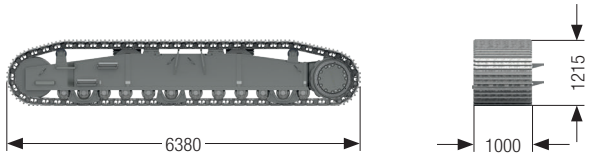

Crawler type 260

Weight t 10.3

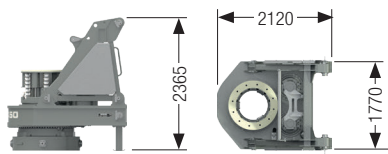

BAT 450.1

Weight t 9.0

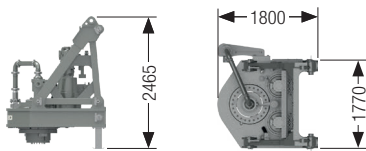

MAT 120

Weight t 6.0

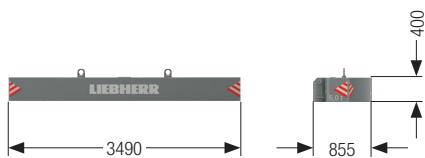

Counterweight (standard)

Weight t 3x 6

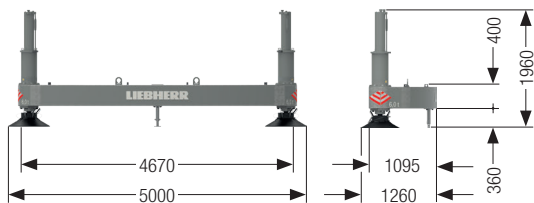

Counterweight (option)

Weight t 1x 6

Options

Adapter for casing oscillator	t 1.3
Jack-up system (incl. adapter for casing oscillator)	t 3.9
Elevating working platform	t 0.5
Concrete supply line	t 0.8

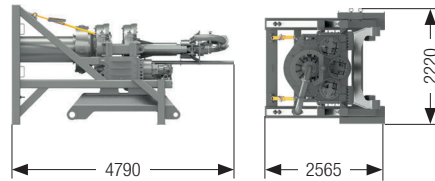

DBA 300

Weight t 11.8

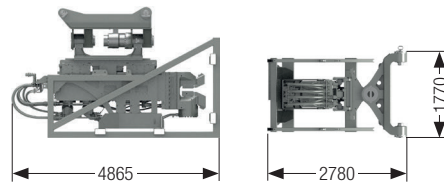

Vibrator slim design LV 36

Weight t 12.7



Additional counterweight (option, only for double rotary drilling)

Weight t 2x 3

Full displacement drilling

BAT 450.1

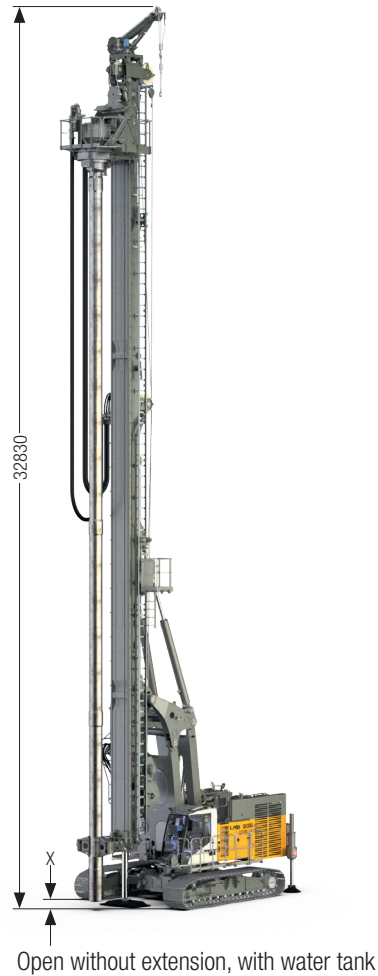
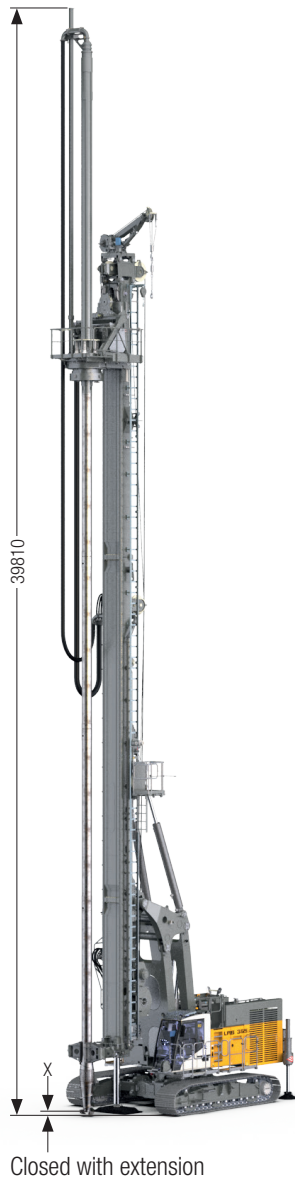

Performance data

Rotary drive - torque	kNm	450
Rotary drive - speed	rpm	38
Max. drilling depth	m	25.8
Drilling depth with 10 m Kelly extension	m	35.8
Max. pull force (crowd winch and Kelly winch)	kN	900
Max. drilling diameter*	mm	600

Above drilling depths are valid for the use of standard tools and for the X value of 580 mm shown in the illustration.

Using the 22 m leader the given maximum drilling depth must be reduced by 5 m.

* Other drilling diameters available on request

Continuous flight auger drilling

BAT 450.1

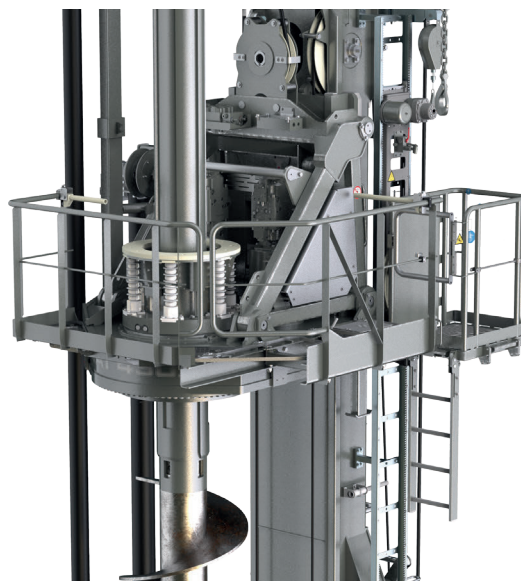
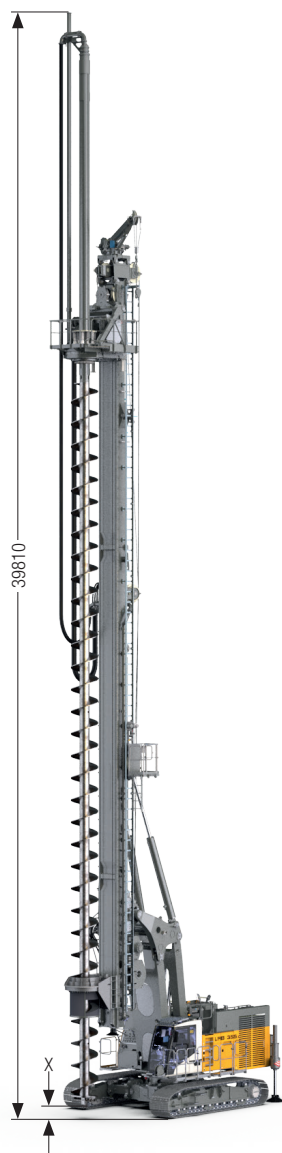

Detailed view of BAT 450.1

Performance data

Rotary drive - torque	kNm	450
Rotary drive - speed	rpm	38
Max. drilling depth	m	25.5
Drilling depth with 10 m Kelly extension	m	35.5
Max. pull force (crowd winch and Kelly winch)	kN	900
Max. drilling diameter*	mm	1200

Above drilling depths take into account that an auger cleaner is used and the cardan joint has been removed.

Above drilling depths are valid for the use of standard tools and for the X value of 350 mm shown in the illustration.

Using the 22 m leader the given maximum drilling depth must be reduced by 5 m.

*Other drilling diameters available on request

Double rotary drilling

DBA 300



Performance data

Rotary drive I - torque	kNm	0-300
Rotary drive I - speed	rpm	0-26
Rotary drive II - torque	kNm	0-150
Rotary drive II - speed	rpm	0-30
Max. drilling diameter*	mm	900
Max. pull force (crowd winch and Kelly winch) <small>single fall</small>	kN	650
Max. pull force (crowd winch and Kelly winch) <small>two fall***</small>	kN	900
Max. drilling depth**	m	26

Above drilling depths are valid for the use of standard tools and for an X value of 300 mm.

Using the 22 m leader the given maximum drilling depth must be reduced by 5 m. Due to differences in the max. admissible load capacities, the combinations of drilling depth and drilling diameter may be limited.

* Other drilling diameters available on request

** When using a protective hose, the maximum drilling depth must be reduced by 800 mm

*** When using a two-fall pulling device, the maximum drilling depth must be reduced by 2500 mm

Kelly drilling

BAT 450.1

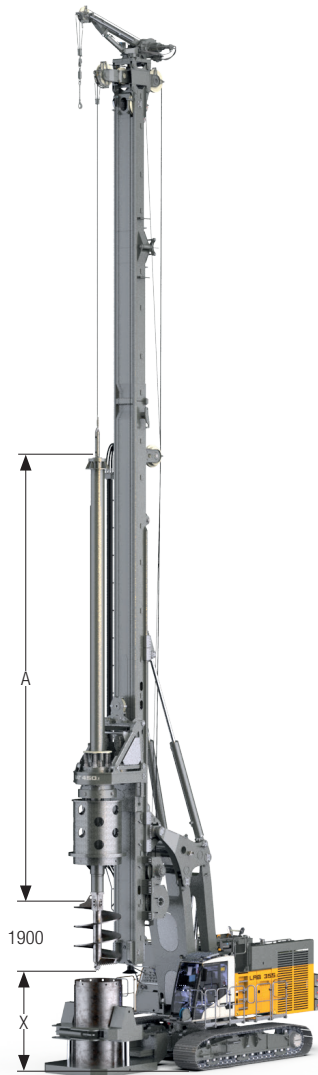

Performance data

Rotary drive - torque	kNm	450
Rotary drive - speed	rpm	38
Max. drilling diameter uncased	mm	2000
Max. drilling diameter* cased	mm	1500
Max. drilling diameter below the leader	mm	4400

Other drilling diameters available on request.

When using a casing oscillator, value X must be reduced by 1600 mm.

*Depends on the design of the casing driver

Kelly bars

	A	X**	Drilling depth	Weight
	mm	m	m	t
MD 36/3/30	11900	14.8	27.0	7.6
MD 36/3/36	13900	12.8	33.0	9.2
MD 36/4/30	9950	16.8	27.0	8.5
MD 36/4/42	12950	13.8	39.1	10.9
MD 36/4/48	14450	12.3	45.1	12.1
MD 36/4/54	15950	10.8	51.1	13.0
MD 36/4/60	17450	9.3	57.1	14.1
MD 36/4/66	18950	7.8	63.1	15.3

** Values valid for 27 m leader. For machines with 22 m leader value X is reduced by 5 m.

Soil mixing

3MA 100

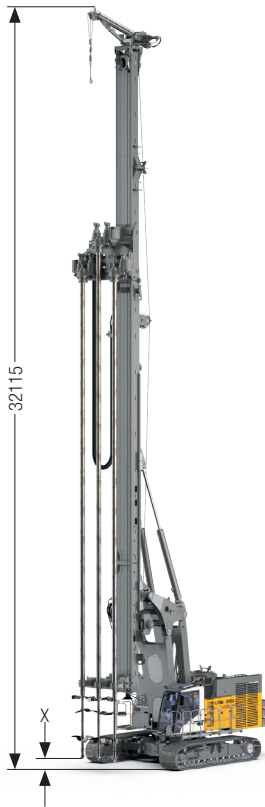

MAT 120

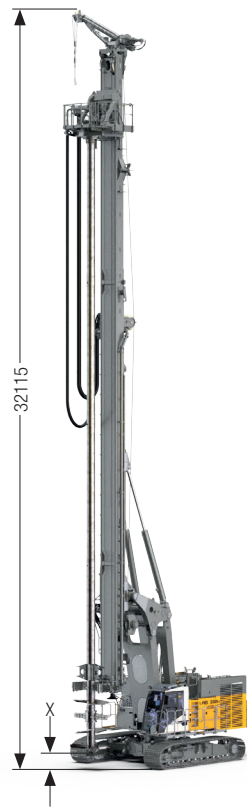

BAT 450.1

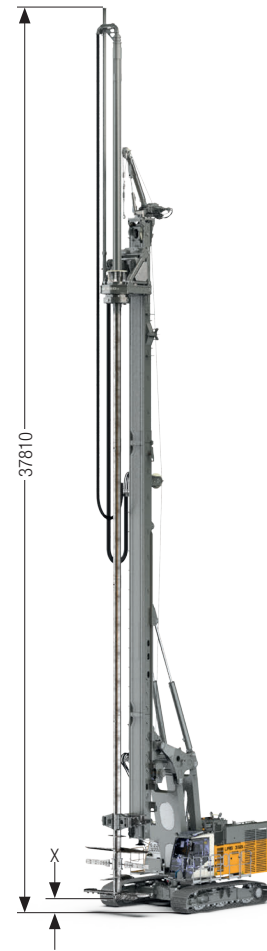

Performance data 3MA 100

Rotary drive - torque	kNm	0-106
Rotary drive - speed	rpm	0-75
Swing range mixing drive	°	+/- 30
Centre-to-centre distance adjustable in steps of 56 mm	mm	600-800
Max. mixing depth	m	26
Max. pull force	kN	650

Above mixing depth is valid for the use of standard tools and for the X value of 300 mm shown in the illustration.

Performance data MAT 120

Rotary drive - torque	kNm	115
Rotary drive - speed	rpm	100
Max. mixing depth	m	26
Max. mixing diameter*	mm	1500

Above mixing depth is valid for the use of standard tools and for the X value of 300 mm shown in the illustration.

*Other mixing diameters available on request

Performance data BAT 450.1

Rotary drive - torque	kNm	450
Rotary drive - speed	rpm	38
Max. mixing depth	m	25.6
Mixing depth with 10 m Kelly extension	m	35.6
Max. mixing diameter*	mm	3400

Above mixing depth is valid for the use of standard tools and for the X value of 760 mm shown in the illustration.

*If the mixing diameter is 2000 mm or more the mixing paddle is always located below the leader, other diameters available on request

Using the 22 m leader the given maximum mixing depths must be reduced by 5 m.

Vibrator slim design

LV 36

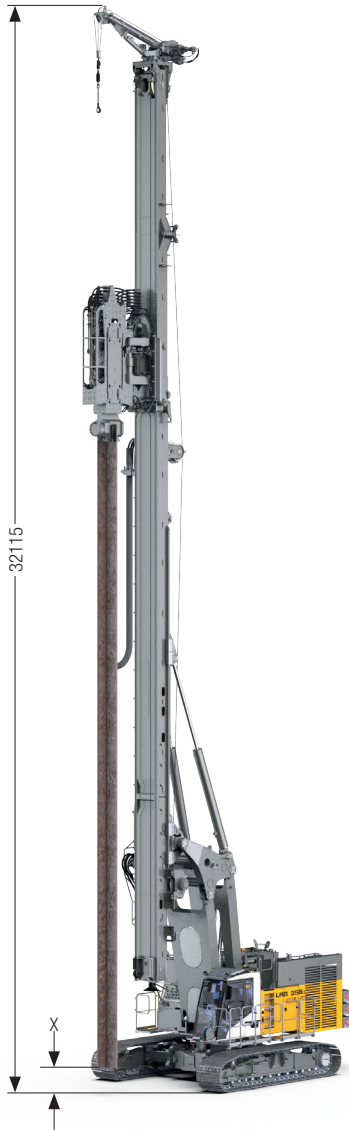

Performance data

Static moment	kgm	0-36
Max. frequency	rpm	0-2200
Max. pull force	kN	1910
Total weight without clamp	kg	9535
Dynamic weight with clamp	kg	6300
Max. pile element length	m	26.5
Swing range vibrator	°	-87 / +80

The given pile element length is valid for the X value of 500 mm shown in the illustration.
Using the 22 m leader the given maximum pile element length must be reduced by 5 m.

Ring vibrator

32 VMR



Performance data

Static moment	kNm	0-32
Max. frequency	rpm	2300
Max. pull force	kN	1860
Pile element diameter	mm	356-610
Max. pile element length	m	40
Total weight	kg	13900

Using the 22 m leader the given maximum pile element length must be reduced by 5 m.

Hydraulic hammer

H 15L



Performance data

Drop weight	t	10
Max. rated energy	kNm	150
Blow rate max. energy	blows/min	30
Max. blow rate	blows/min	80
Kelly winch (pile winch)	kN	250
Total weight	kg	18140
Max. pile length	m	24.5

The given pile element length is valid for the X value of 500 mm shown in the illustration.
Using the 22 m leader the given maximum pile element length must be reduced by 5 m.

BAT 450.1

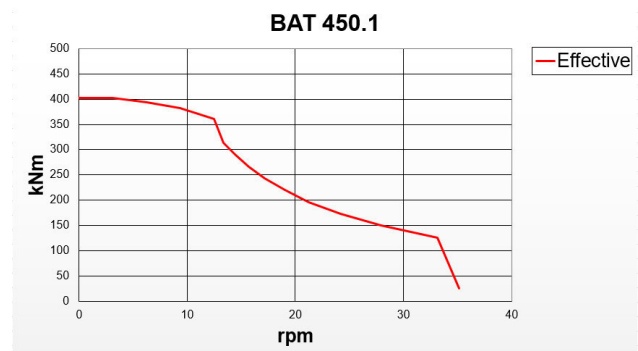
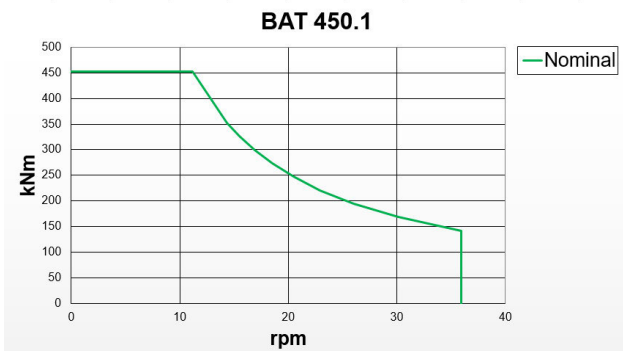
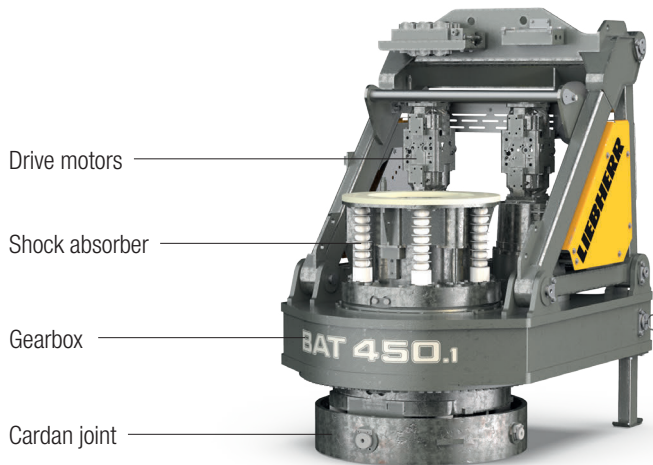

Kelly shock absorber:

- Newly developed Kelly shock absorber for highest demands
- Possibility of adjusting the strength of the Kelly shock absorber for different Kelly bar weights

Automatic gearbox for best operating comfort:

- No stopping required to change gears
- No interruption of the drilling process
- Continuous optimization of speed

Highest availability through easy set-up:

- No mechanical shift gearbox
- Low maintenance requirements

Flexibility through modular design:

- Exchangeable cardan joint for other casing drivers
- Exchangeable drive adapters for use of other Kelly bars
- Quickly exchangeable equipment for other methods of operation

The Liebherr Group of Companies



Wide Product Range

The Liebherr Group is one of the largest construction equipment manufacturers in the world. Liebherr's high-value products and services enjoy a high reputation in many other fields. The wide range includes domestic appliances, aerospace and transportation systems, machine tools and maritime cranes.

Exceptional Customer Benefit

Every product line provides a complete range of models in many different versions. With both their technical excellence and acknowledged quality, Liebherr products offer a maximum of customer benefits in practical applications.

State-of-the-art Technology

To provide consistent, top quality products, Liebherr attaches great importance to each product area, its components and core technologies. Important modules and components are developed and manufactured in-house, for instance the entire drive and control technology for construction equipment.

Worldwide and Independent

Hans Liebherr founded the Liebherr family company in 1949. Since then, the family business has steadily grown to a group of more than 130 companies with nearly 44,000 employees located on all continents. The corporate headquarters of the Group is Liebherr-International AG in Bulle, Switzerland. The Liebherr family is the sole owner of the company.

www.liebherr.com

Liebherr-Werk Nenzing GmbH

Dr. Hans Liebherr Str. 1, 6710 Nenzing/Austria

+43 50809 41-473

www.liebherr.com, foundation.equipment@liebherr.com

[facebook.com/LiebherrConstruction](https://www.facebook.com/LiebherrConstruction)